

BV12-2466T-PN10 - Vrije As

Lug type vlinderklep, te monteren tussen flenzen PN10, vrije as
Norm Bouwlengte: EN 558-1 Tabel 1 serie 20

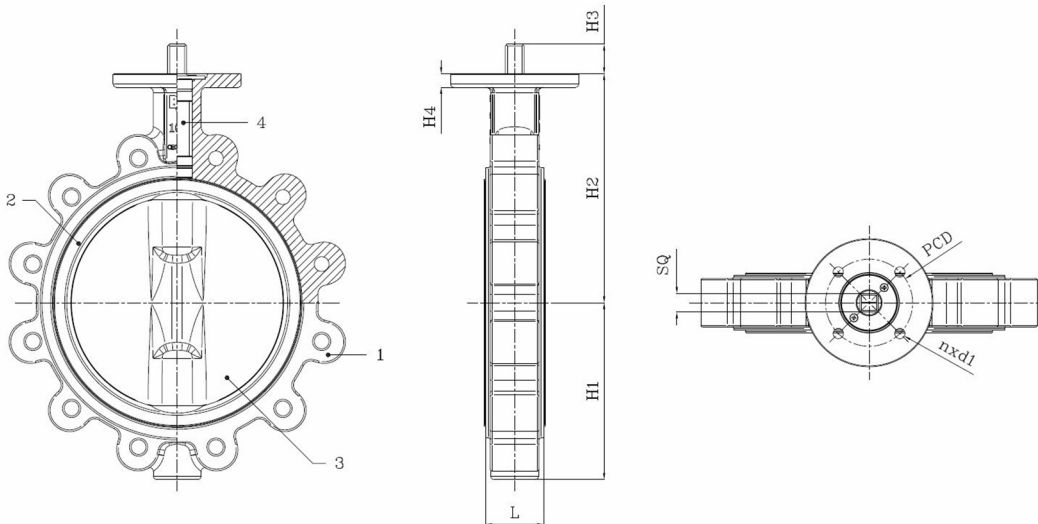

Artikelnummer	Belven Ref.
121026T0200	BV12-2466T-PN10-DN200 - BARE SHAFT
121026T0250	BV12-2466T-PN10-DN250 - BARE SHAFT
121026T0300	BV12-2466T-PN10-DN300 - BARE SHAFT



DN/Inch	L	H1	H2	H3	H4	SQ	ISO	PCD	n x d1	Drukl.	Gewicht(kg)
DN200 (8")	60	168	237	34,5	16	17	F10	102	4 x d12	PN10	16,10
DN250 (10")	68	207	268,3	34,5	16	22	F10	102	4 x d12	PN10	29,70
DN300 (12")	78	243,5	308,5	34,5	16	27	F12	125	4 x d14	PN10	44,70

Item 1	Item 2	Item 3	Item 4
Materiaal Huis	Materiaal Zitting	Materiaal Klepblad	Materiaal Bediening
Nodulair gietijzer : GGG40 + Epoxy coating	PTFE	Roestvrijstaal : CF8M	RVS Spindel AISI 416