

## BV12S-GAS-2425NG-PN16 - Wormwielkast DVGW

### gekeurd

Lug type vlinderklep, te monteren tussen flenzen PN16, met wormwielkast, DVGW Gas gekeurd volgens EN 13774:2013  
Norm Bouwlengthe: EN 558-1 Tabel 1 serie 20

Met NBR-GAS zitting volgens EN 685



Artikelnummer	Belven Ref.
12SOG3044NG30200	BV12S-GAS-2425NG-PN16-DN200 - GEARBOX
12SOG3044NG30250	BV12S-GAS-2425NG-PN16-DN250 - GEARBOX
12SOG3044NG30300	BV12S-GAS-2425NG-PN16-DN300 - GEARBOX

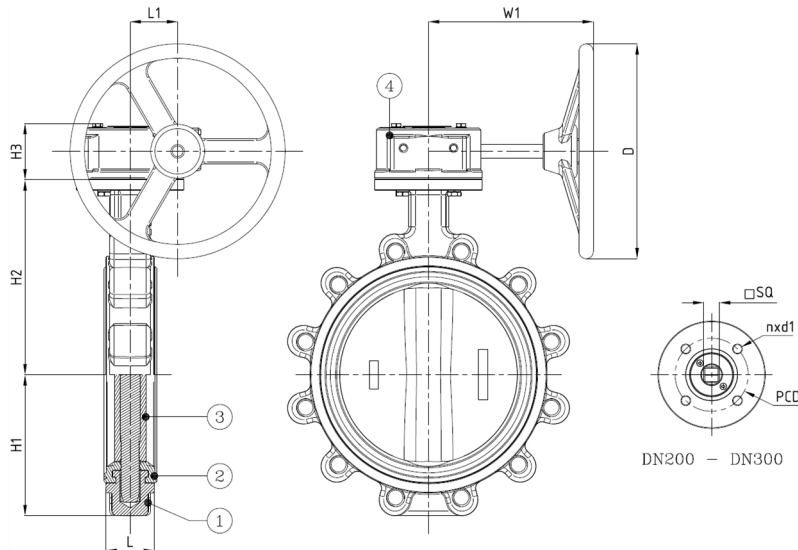

DN/Inch	L	H1	H2	H3	H4	L1	SQ	ISO	PCD	n x d1	D	W1	Drukl.	Gewicht(kg)
DN200 (8")	60	165	243,5	80,5	45	63	17	F10	102	4 x d12	300	237	PN16	29,20
DN250 (10")	68	202	273	80,5	45	63	22	F10	102	4 x d12	300	237	PN16	40,00
DN300 (12")	78	235	311	80,5	45	63	27	F12	125	4 x d14	300	237	PN16	58,70

Item 1	Item 2	Item 3	Item 4
<b>Materiaal Huis</b>	<b>Materiaal Zitting</b>	<b>Materiaal Klepblad</b>	<b>Materiaal Bediening</b>
Nodulair gietijzer : GGG40 + Epoxy coating	NBR-GAS	Vernikkeld : GGG40 + Ni	Gietijzer