

BV12-2466V-PN16 - Wormwielkast

Lug type vlinderklep, te monteren tussen flenzen PN16, met wormwielkast
Norm Bouwlengte: EN 558-1 Tabel 1 serie 20

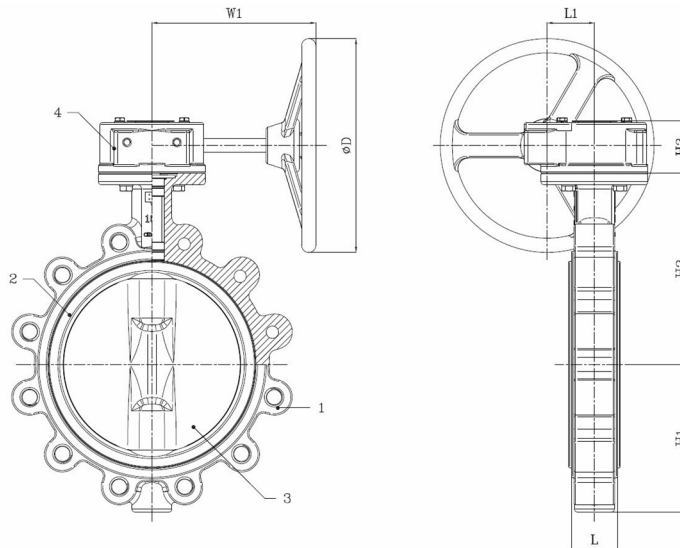

Artikelnummer	Belven Ref.
121126V3200	BV12-2466V-PN16-DN200 - GEARBOX
121126V3250	BV12-2466V-PN16-DN250 - GEARBOX
121126V3300	BV12-2466V-PN16-DN300 - GEARBOX



DN/Inch	L	H1	H2	H3	L1	D	W1	Drukkl.	Gewicht(kg)
DN200 (8")	60	168	237	80,5	63	300	237	PN16	27,00
DN250 (10")	68	207	268,3	80,5	63	300	237	PN16	36,00
DN300 (12")	78	243,5	308,5	80,5	78	300	225	PN16	67,00

Item 1	Item 2	Item 3	Item 4
Materiaal Huis	Materiaal Zitting	Materiaal Klepblad	Materiaal Bediening
Nodulair gietijzer : GGG40 + Epoxy coating	VITON	Roestvrijstaal : CF8M	Gietijzer