

BV12-2466T-PN10 - Hendel

Lug type vlinderklep, te monteren tussen flenzen PN10, met hendel
Norm Bouwlengte: EN 558-1 Tabel 1 serie 20

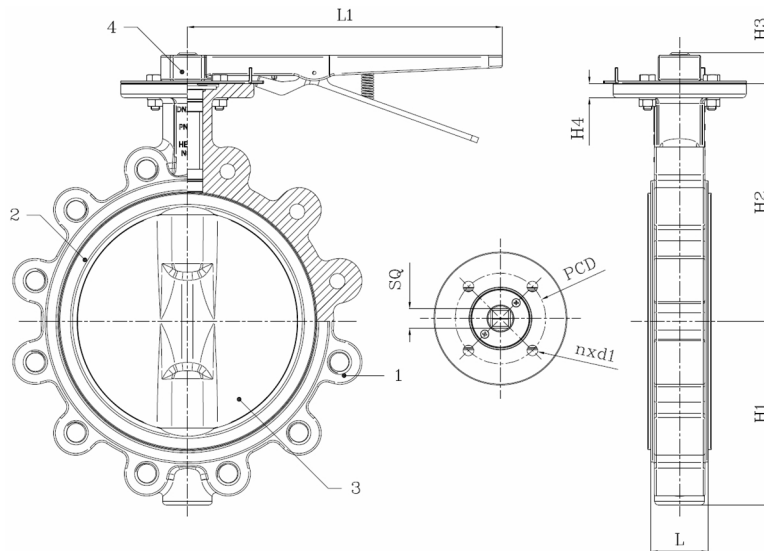

Artikelnummer	Belven Ref.
121026T1200	BV12-2466T-PN10-DN200 - LEVER
121026T1250	BV12-2466T-PN10-DN250 - LEVER
121026T1300	BV12-2466T-PN10-DN300 - LEVER



DN/Inch	L	H1	H2	H3	H4	L1	SQ	ISO	PCD	n x d1	Drukkl.	Gewicht(kg)
DN200 (8")	60	168	237	34,5	16	356	17	F10	102	4 x d12	PN10	18,00
DN250 (10")	68	207	268,3	34,5	16	356	22	F10	102	4 x d12	PN10	31,50
DN300 (12")	78	243,5	308,5	34,5	16	356	27	F12	125	4 x d14	PN10	46,50

Item 1	Item 2	Item 3	Item 4
Materiaal Huis	Materiaal Zitting	Materiaal Klepblad	Materiaal Bediening
Nodulair gietijzer : GGG40 + Epoxy coating	PTFE	Roestvrijstaal : CF8M	Gietijzer