

Technical Product Sheet

BV12-2466T-PN10 - Lever

Lug type butterfly valve, mounting between flanges PN10, with lever

Face to Face Standard: EN 558-1 Table 1 series 20



Item Number	Belven Ref.
121026T1200	BV12-2466T-PN10-DN200 - LEVER
121026T1250	BV12-2466T-PN10-DN250 - LEVER
121026T1300	BV12-2466T-PN10-DN300 - LEVER

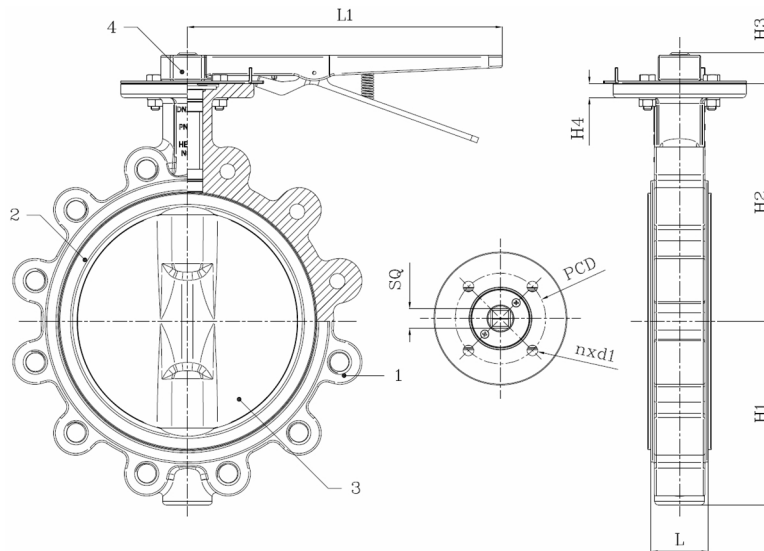

DN/Size	L	H1	H2	H3	H4	L1	SQ	ISO	PCD	n x d1	Press.Cl.	Weight(kg)
DN200 (8")	60	168	237	34,5	16	356	17	F10	102	4 x d12	PN10	18.00
DN250 (10")	68	207	268,3	34,5	16	356	22	F10	102	4 x d12	PN10	31.50
DN300 (12")	78	243,5	308,5	34,5	16	356	27	F12	125	4 x d14	PN10	46.50

Item 1	Item 2	Item 3	Item 4
Body Material	Seat Material	Disc Material	Actuator Material
Ductile iron : GGG40 + Epoxy coating	PTFE	Stainless steel : CF8M	malleable iron